

Catalog

Mounts

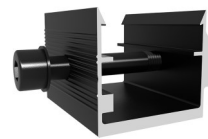

Racking



Systems



On behalf of our organization, thank you for considering SunModo for your racking needs.

At SunModo, we are dedicated to supporting the professional installer with robust and worry-free products, great technical support, and a complete line of innovative racking and mounting solutions.

We look forward to working with you!

The SunModo Team

SMR System

- Overview. 3
- SMR100 & SMR200 4
- Clamps 5
- L-Foot Adaptor 6
- Rail Splice 6
- Accessories 7

Roof Attachments

Composite Shingle Roof

- NanoMount 8
- SoloFlash 9
- EZ Roof Mount 10

Metal Roof

- EZ Metal Roof Mount. 12
- RidgeBridge Mount. 14
- EZ Grip Metal Deck Mount 15
- EZ Standing Seam Clamp 16

Contact Information

Phone: 1-360-844-0048
 Fax: 1-503-863-3878
 General: info@sunmodo.com
 Sales: sales@sunmodo.com
 Website: www.sunmodo.com

Disclaimer

Due to continuous product optimization, we reserve the right to change our product information and this product catalog at any time. All previous product catalog information become invalid upon the release of later publications.

Roof Attachments

Tile Roof

- TopTile Mount. 18
- TopTile spacer 18

Standing Seam Rail-Free System

- Overview. 20

SMR Tilt-Up System

- Overview 21
- Components. 22

SunTurf System

(Ground Mount & Roof Mount)

- Overview. 23
- Components. 24

Roof Mount – Pitched Roof SMR System Overview

SunModo introduces the SMR System, the best value pitched roof mounting system on the market. The SMR System represents a huge leap in racking technology. Optimized design makes the SMR Rails not only the lightest but also the strongest rails on the market. With fast and easy Pop-On Clamps and L-Foot Adaptors, professional installers can mount, adjust, and secure PV panels with a single tool. Save money on materials and installation time.

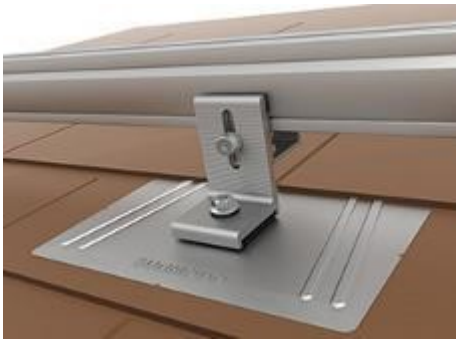

A full range of mounts available (SoloFlash shown) to best fit your system needs and requirements.

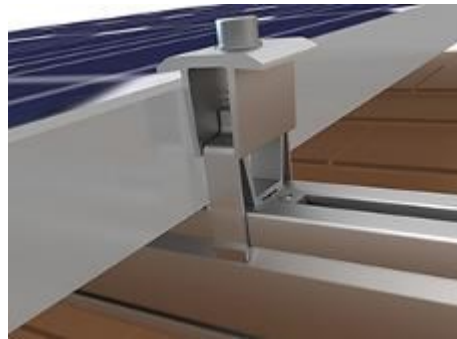

The Bonding Pop-On Universal Mid Clamps accommodate PV module frame heights ranging from 30mm to 50mm.

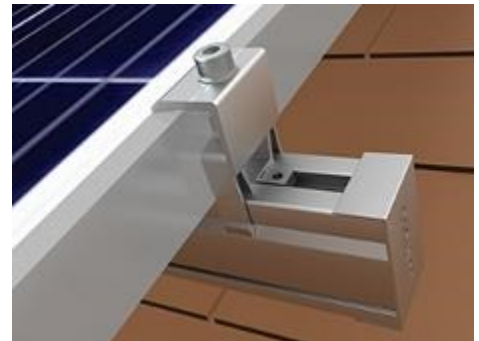

Pop-On End Clamps are adjustable for different module frame heights and provide fast and secure attachment of modules.

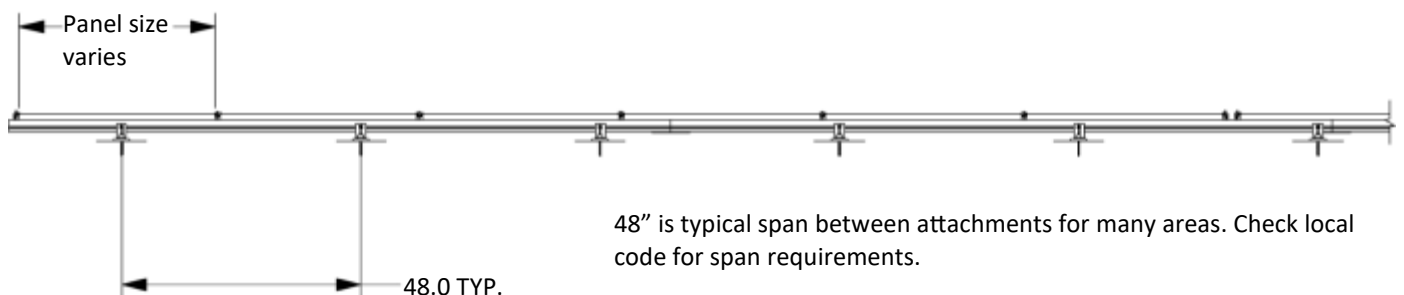

48" is typical span between attachments for many areas. Check local code for span requirements.

SMR Rail

The SMR System represents a huge leap in racking technology. Optimized design makes the SMR Rails not only the lightest but also the strongest rails on the market.

SMR100 Rail achieves 4' span or more up to 60 psf snow load or 190 mph winds.

SMR200 Rail achieves 4' span or more up to 90 psf snow load or 190 mph winds.

Manufactured in 168" stock size in black. SMR100 and SMR200 rails are extruded 6005-T5 aluminum.



SMR100



SMR200

Part Number	Description
A20422-168-BK	SMR100 Rail, Black Anodized, 168"
A20453-168-BK	SMR200 Rail, Black Anodized, 168"

SMR Pop-On Mid Clamp

The Bonding Pop-On Universal Mid Clamps accommodate PV module frame heights ranging from 30mm to 50mm. The fastest installing Mid Clamps on the market.



Part Number	Description
K10417-BK1	Mid Clamp, SMR Pop-On, Black

SMR Pop-On End Clamp

End Clamps are adjustable for different module frame heights and provide fast and secure attachment of modules.



Part Number	Description
K10418-BK1	End Clamp, SMR Pop-On, Black

SMR Pop-On Shared Rail Mid Clamp

Easily adapt racking to Shared Rail install. Uses the same Pop-On technology to provide fast and easy install.



Part Number	Description
K10419-BK1	Shared Rail Mid Clamp, SMR Pop-On, Black

SMR Pop-On Shared Rail End Clamp

Easily adapt racking to Shared Rail install. Uses the same Pop-On technology to provide fast and easy install.



Part Number	Description
K10420-BK1	Shared Rail End Clamp, SMR Pop-On, Black

SMR Structural Slice

Structural splice with fast and easy single bolt installation.



Part Number	Description
K10421-002	Structural Splice, SMR100
K10462-BK2	Structural Splice, SMR200

SMR L- Foot Adaptor

Fast and easy Pop-On L-Foot Adaptor speeds installation and eliminates old-fashioned T-Bolts. Install fast with full confidence in every attachment.



Part Number	Description
K10433-BK1	L Foot Adaptor, SMR100, Black
K10434-BK1	L Foot Adaptor, SMR200, Black

SMR End Cap

The SMR end caps provide a clean finished look to the system.



Part Number	Description
A20440-BK1	Rail End Cap, SMR100, Black
A20440-BK2	Rail End Cap, SMR200, Black

Grounding Lug

The Grounding Lug provides proper grounding of the PV System per UL 2703 and NEC 690.47



Part Number	Description
K10179-004	SMR Grounding Lug

Cable Clip

The cable clip attaches to the channel on the SMR rail to provide a neat and effective solution for PV wire management.

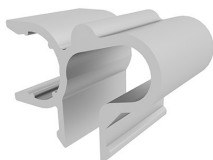

Part Number	Description
A20162-001	Cable Clip, Clear

Microinverter Mount

The Microinverter Mount bonds to compatible microinverters and power optimizers.



Part Number	Description
K50052-001	SMR Microinverter Mount Kit

Roof Attachment – Composite Shingle NanoMount®

Damaging roof shingles used to be one of a solar installers’ worst challenges.

Now, the easy, affordable solution is NanoMount®, SunModo’s patented solar mounting innovation. The mount eliminates the need for lifting shingle and dramatically cutting down the installation time.

The patented mount is High-Velocity Hurricane Zone Approved – Passed TAS 100 (a) Wind-Driven Rain Test. The Ultra Soft Weather Resistant gasket is integrated with the mount.

All materials are compatible with residential roof coverings as well as commercial single-ply roof membranes.



Part Number	Description
K50058-BK1	NanoMount, Black
K50049-BK1	Lag Bog with Sealing Washer, Black
K50055-BK1	Deck Screw with Sealing Washer, Black

Roof Attachment – Composite Shingle SoloFlash™

SunModo is proud to introduce SoloFlash™, the most economical flashing on the market.

The cone-shaped flashing design diverts water from the roof penetration while the stamped emboss features stiffen the flashing to minimize bending. The L-foot has serrated surface on both sides for rail mounting. The Ultra Soft Weather Resistant gasket is integrated with the L-Foot for maximum water protection.

The mount is High-Velocity Hurricane Zone Approved – Passed TAS 100 (a) Wind-Driven Rain Test.

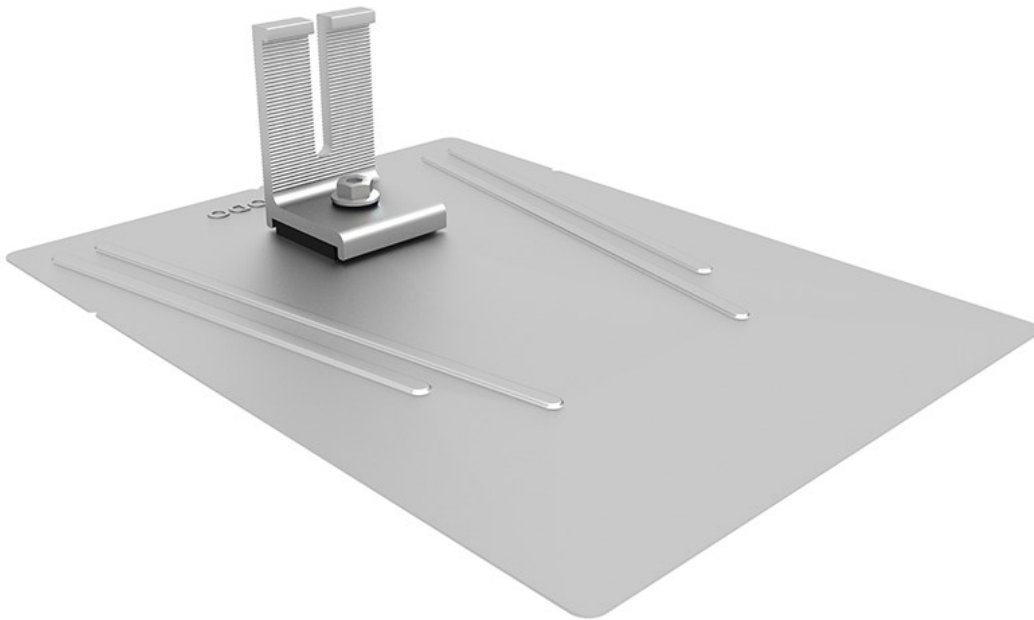

Part Number	Description
K50538-003	SoloFlash, Clear
K50538-BK3	SoloFlash, Black

Roof Attachment – Composite Shingle EZ Roof Mount™ w/ L-Foot

Save time, hassle, and callbacks by using EZ Roof Mount™ for any composite shingle roof.

Specially designed with sealing point protected from elements, the kit (both lag bolt and decking screw version) is IAMPO certified for waterproofing and structural integrity.

The kit includes one flashing (10.00 x 12.48 x 0.04 inches) , one versatile aluminum base designed for multiple configurations, one EZ L-Foot and all hardware. U.S. Patent Number 8,122,648



Versatile aluminum base for multiple configurations.

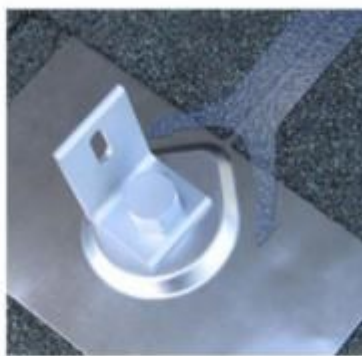

Flashing designed to redirect water flow.



Available in black.

Part Number	Description
K10068-001	EZ Roof Mount, EZ L-Foot, Clear
K10068-BK1	EZ Roof Mount, EZ L-Foot, Black
K10068-020	EZ Roof Mount, EZ L-Foot, Decking Screws, Clear
K10068-B20	EZ Roof Mount, EZ L-Foot, Decking Screws, Black
K10068-BK2	EZ Roof Mount, 4" Tall L Foot, Black

Roof Attachment – Composite Shingle EZ Roof Mount w/ Standoff

Save time, hassle, and callbacks by using EZ Roof Mounts for any composite shingle roof.

Specially designed with sealing point protected from elements, the kit provides exceptional resistance to corrosion and wear.

This kit includes one flashing, one versatile aluminum base designed for multiple configurations, one 2" standoff and all hardware.

U.S. Patent Number 8,122,648



Perfect for top mounting rail.



Add a L Foot for side mounting rails.



L Foot version available.

Part Number	Description
K10070-002	EZ Roof Mount, 2" Standoff, Clear
K10070-BK2	EZ Roof Mount, 2" Standoff, Black

Roof Attachment – Metal EZ Metal Roof Mount w/ L-Foot

With few components and single penetration, the EZ Metal Roof Mount Kit with L-Foot allows for fast installation. Secures tightly into wood beams.

The mount is High-Velocity Hurricane Zone Approved – Passed TAS 100 (a) Wind-Driven Rain Test.

The kit includes one EZ Metal Roof Shoe with a thick EPDM gasket for a water tight seal, one Hex Cap, one EZ L-Foot and all hardware.

U.S. Patent Number 8,136,311



Single penetration mount



Thick EPDM gasket for superior water tight seal.



L-Foot can swivel in any direction.

Part Number	Description
K10082-001	EZ Metal Roof Mount, EZ L-Foot, Clear
K10082-BK1	EZ Metal Roof Mount, EZ L-Foot, Black
K10082-002	EZ Metal Roof Mount, 4" Tall EZ L-Foot, Clear
K10082-BK2	EZ Metal Roof Mount, 4" Tall EZ L-Foot, Black

Roof Attachment – Metal

EZ Metal Roof Mount w/ Standoff

With few components and single penetration, the EZ Metal Roof Mount Kit with Standoff allows for fast installation. Secures tightly into wood beams.

The mount is High-Velocity Hurricane Zone Approved – Passed TAS 100 (a) Wind-Driven Rain Test. U.S. Patent Number 8,136,311

We also offer EZ Metal Roof Mount Kit with Two-Screw for fast and secure installation into metal purlins.

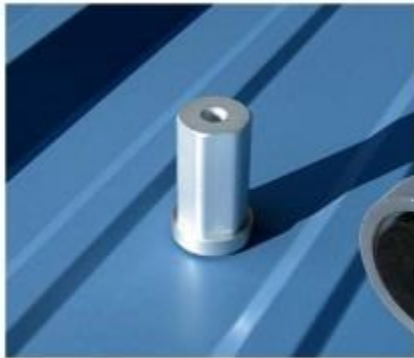

Thick EPDM gasket for superior water tight seal.



Solid aluminum standoff that comes in different lengths.



Single penetration mount

Part Number	Description
K10064-002	EZ Metal Roof Mount , 2" Standoff, Clear
K10064-BK2	EZ Metal Roof Mount, 2" Standoff, Black
K10064-005	EZ Metal Roof Mount, 5" Standoff, Clear
K10154-001	EZ Metal Roof Mount with 'T Foot' and Two Mount Holes

Roof Attachment – Metal RidgeBridge™ Mount Kit

Designed for maximum flexibility, the RidgeBridge™ Mount can be attached to most traditional or trapezoidal corrugated roof profiles.

The RidgeBridge Mounts are compatible with corrugation pitch heights ranging from 3/4" to 1-1/2".

The kit can be combined with L-Adaptor to change the orientation of rail at right angles to corrugations.



Part Number	Description
K10211-002	3/4 Pitch Height RidgeBridge Mount (no lag bolt)
K10212-002	1 Pitch Height RidgeBridge Mount (no lag bolt)
K10213-002	1-1/2 Pitch Height RidgeBridge Mount (no lag bolt)
K10066-016	RidgeBridge L-Adaptor
A50011-001	Tool, RidgeBridge Mount Selection

Roof Attachment – Metal EZ Grip Metal Deck Mount

Need a metal roof decking solution? Look no further than SunModo’s EZ Grip Metal Deck Mount.

Designed for easy installation into sheet metal, plywood or OSB roof decking, the EZ Grip Metal Deck Mount works for the most popular R-Panel and U-Panel trapezoidal types of metal roofs.

The aluminum extruded base easily clears roof profiles 7/16” tall by 1-1/2” wide. The EPDM gaskets on the washers and on the aluminum extruded base combine to provide a water tight seal at the roof penetration site.

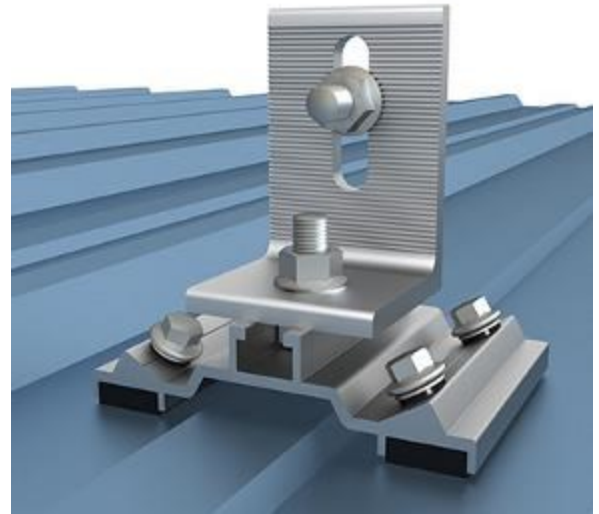

Part Number	Description
K50532-001	EZ Grip Metal Deck Mount
K50532-002	EZ Grip Metal Deck Mount (for 26ga SM)

Roof Attachment – Standing Seam

1-inch EZ Standing Seam Clamp

PV installations on metal roofs just got easier with SunModo’s own family of innovative standing seam clamps.

The clamp features roof-safe oval end set screw to eliminate damage to the roof. The set screw of the 1-inch clamp can be installed on either the vertical leg of the clamp or on the 10-degree leg of the clamp. Repositioning the set screw allows for this clamp to fit on a wide variety of standing seam roof profiles. Available in 50mm width standard version with 2 set screws or 30mm width mini version with 1 set screw.

We also offer 1” Standing Seam Rail-Free kit. See page 32 for details.

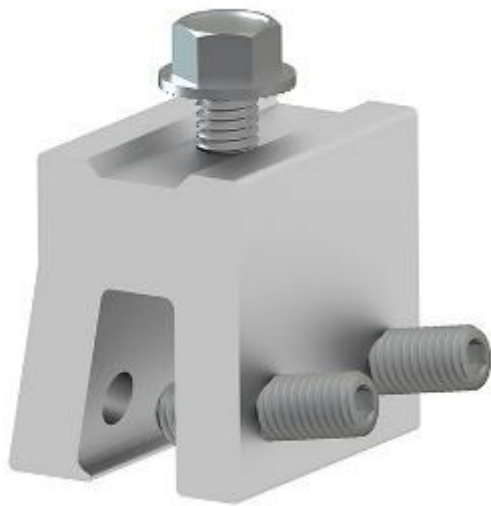

K50200-001



K50200-002

Part Number	Description
K50200-001	1” EZ Standing Seam Clamp, Standard
K50200-002	1” EZ Standing Seam Clamp, Mini

Roof Attachment – Standing Seam

2-inch EZ Standing Seam Clamp

PV installations on metal roofs just got easier with SunModo’s own family of innovative standing seam clamps.

The clamp features roof-safe oval end set screw to eliminate damage to the roof. The 2-inch clamp installs in situ at the desired seam attachment location. No more sliding the clamp up the roof line with this unique two-part assembly. Available in 50mm width standard version with 2 set screws or 30mm width mini version with 1 set screw.

We also offer 2” Standing Seam Rail-Free kit. See page 32 for details.



K50210-001



K50210-002

Part Number	Description
K50210-001	2” EZ Standing Seam Clamp, Standard
K50210-002	2” EZ Standing Seam Clamp, Mini

Roof Attachment – Tile

TopTile™ Mount

TopTile™ Mount is the world’s first PV mounting system that is mounted entirely above the tiles. The mounting system spares an installer the need to deconstruct the tile roof.

The patented mount eliminates the need to deconstruct the tile roof and significantly reduce time and minimize tile breakage during installation. The system also allows installation on the ridges of curved tiles for superior water leak protection.

The mount is High-Velocity Hurricane Zone Approved – Passed TAS 100 (a) Wind-Driven Rain Test.



K10466-00X



K10461-1XX

Part Number	Description
K10466-005	5" Rafter TopTile Mount
K10466-007	7" Rafter TopTile Mount
K10466-008	8" Rafter TopTile Mount
K10461-105	5" Wood Deck TopTile Mount
K10461-107	7" Wood Deck TopTile Mount
K10461-108	8" Wood Deck TopTile Mount
A20461-001	TopTile Spacer, 1"

Roof Attachment

L-Foot Kits

SunModo L-Foot Kits are heavy duty and can be used in a variety of ways for mounting. One long vertical slot for adjustment of rail when facing uneven roofing. Serrated on both sides for secure mounting on the rail. We also offer a Tall L-Foot version that gives you more flexibility on vertical adjustments.



Part Number	Description
K10066-001	L-Foot Kit, Clear
K10066-BK1	L-Foot Kit, Black
K10096-001	L-Foot Kit, 4" Tall, Clear
K10096-BK1	L- Foot Kit, 4" Tall, Black

Conduit Clamp

The Conduit Clamp provides a quick and easy way to manage 3/4" and 1" diameter conduit to any roof top solar installation.



Part Number	Description
A20212-001	1" Conduit Clamp
A20213-001	3/4" Conduit Clamp

Roof Mount – Pitched Roof

SunDock™ Standing Seam Rail-Free System

The SunDock™ Standing Seam Rail-Free system is a Mid Clamp and End Clamp all rolled into one. This unique pre-assembled universal clamping system can secure PV panels ranging in height from 30mm to 50mm and it attaches to almost any standing seam roof profile.

SunDock’s integrated bonding pins address the stringent bonding requirements of UL2703 creating a continuous bond path throughout the array.



1” Standing Seam Rail-Free Kit



Part Number	Description
K50214-001	1” Standing Seam Rail-Free Kit

2” Standing Seam Rail-Free Kit



Part Number	Description
K50215-001	2” Standing Seam Rail-Free Kit

Roof Mount – Flat Roof SMR Tilt-Up System Overview

SMR Tilt-up is a single row tilt-up system ideal for light roof structure application.

Utilizing our new SMR rail and pop-on technology, the system offers various tilt degree options to maximize the power output at lower cost. Designed to meet the needs of a variety of roof structures, the installation is easy and quick to save your labor cost and time.



Flat and low-slope roof mounting L Foot, combined with tilt-up rails , provides versatile pitch angles. With a variety of attachment options, the system can be configured in endless ways to met your specific needs.



Roof Mount – Flat Roof SMR Tilt-Up System Components

SunModo offers three standard tilt-up rail lengths of 8, 14 and 25 inches to achieve tilt angles of 10 and 20 degrees. A 10-foot full length tilt-up rail is also available for on-site cutting, allowing maximum flexibility. The top mount and side mount standoffs are available in 3 lengths.

Tilt-Up Rail Kits



Part Number	Description
K10284-008	8" Tilt Up Rail Kit (Front Leg)
K10284-014	14" Tilt Up Rail Kit (Rear Leg)
K10284-025	25" Tilt Up Rail Kit (Rear Leg)
A20276-120	120" Tilt Up Rail

Top Mount Standoff



Part Number	Description
A20055-004	4" Top Mount Standoff
A20055-006	6" Top Mount Standoff
A20055-008	8" Top Mount Standoff

Side Mount Standoff



Part Number	Description
A20056-005	5" Side Mount Standoff
A20056-007	7" Side Mount Standoff
A20056-009	9" Side Mount Standoff

Roof Mount & Ground Mount SunTurf® System Overview

SunModo introduces the next generation Multi-Purpose System with SunTurf. The streamlined design combines the simplicity of a pipe-based system with next-level engineering.

SunTurf is perfect to elevate above obstructions like HVAC, Pipes and Vents. It can be easily adjusted to account for multiple roof pitches on the site and is engineered to withstand 150 MPH wind.



The system is designed for installers who want a low cost system with high performance. Combine SunTurf with our Ground Screws or Augers and do a complete install of a 15kW system with only one day.



Position the Pipe Cap on top of the vertical pipe and lay the horizontal pipe into the Pipe Cap assembly.

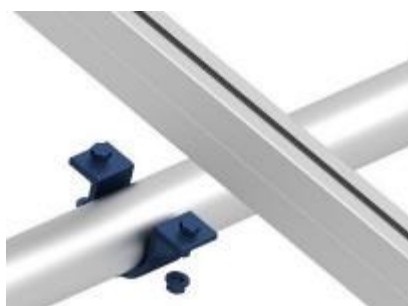

Attach the rail to the pipe using the aluminum pipe clamp kit. To prevent galvanic reaction, the PVC insulator must be installed between the steel pipe and the aluminum rail.

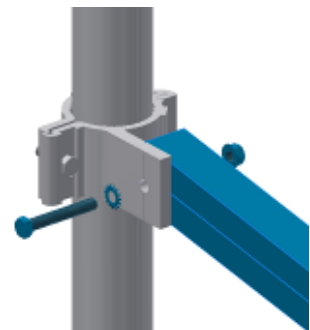

When bracing is required to a post, the pipe clamp kit is used.

HR Rails

SunModo HR rails are specially designed for the SunTurf system to maximize spans and optimize cost and performance. The rails can handle a variety of components such as rail splices, micro-inverters, and clamps.

Manufactured in 2 stock sizes in mill finish. The rails are extruded 6005-T5 aluminum.

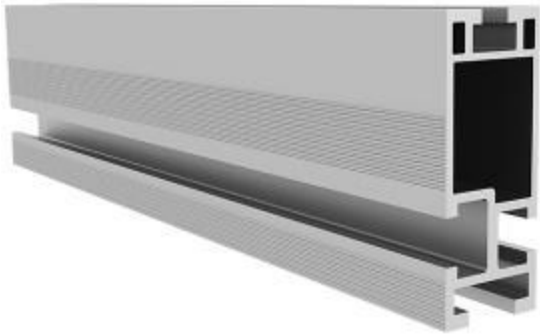

HR250

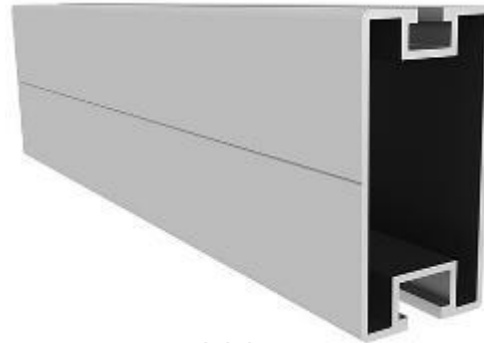

HR300

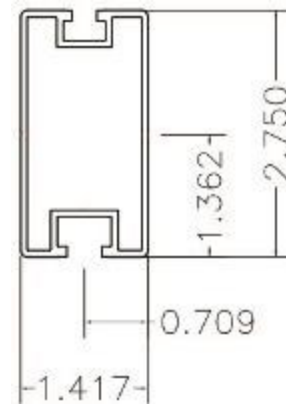
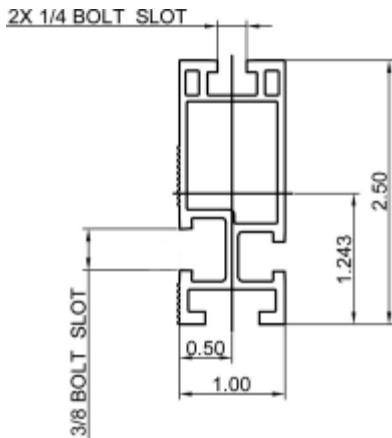

Part Number	Description
A20144-168-ML	HR250, Mill Finish, 168"
A20144-206-ML	HR250, Mill Finish, 206"
A20288-168-ML	HR300, Mill Finish, 168"
A20288-206-ML	HR300, Mill Finish, 206"

Bonding Mid Clamp Kit

Our Pre-Assembled Universal Mid Clamps have a unique T-Bolt locking feature that ensure the T-Bolt remains vertical and in full contact with rail to eliminate pull out. The spring-loaded top clamp and open collar nut accommodates module frames from 30 to 50mm.

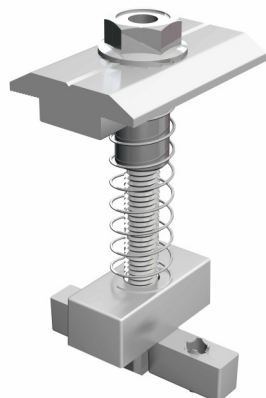

Part Number	Description
K10180-001	Universal Mid Clamp Kit , Clear
K10180-001-BK	Universal Mid Clamp Kit, Black

Bonding Mid Clamp Kit with Shared Rail Adaptor

The shared rail adaptor conveniently converts standard rail to shared rail to allow landscape mounting of PV panels on E-W rails.

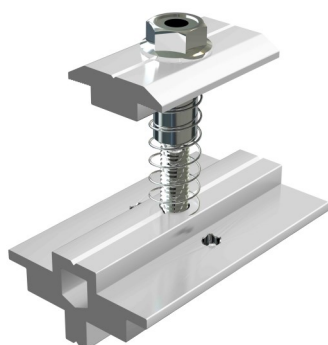

Part Number	Description
K10182-001	Mid Clamp Kit with Shared Rail Adaptor, Clear
K10182-001-BK	Mid Clamp Kit with Shared Rail Adaptor, Black

End Clamp Kit

Our Pre-Assembled End Clamps have added Loctite to easily engage the T-Bolt from the top of the collar nut.

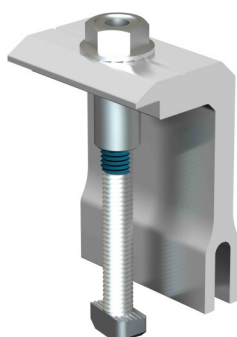

Part Number	Description
K10224-1XX (31-50)	End Clamp Kit, Clear
K10224-1XX (31-50)-BK	End Clamp Kit, Black

SunTurf System Components

Adjustable End Clamp Kit

Our new adjustable end clamps accommodates different PV module frame heights ranging from 30mm to 50mm, by simply changing the locking position of the upper clamp piece.



Part Number	Description
K10299-001	End Clamp Kit, 33-50mm, Clear
K10299-BK1	End Clamp Kit, 33-50mm, Black
K10299-002	End Clamp Kit, 30-46mm, Clear
K10299-BK2	End Clamp Kit, 30-46mm, Black

Shared Rail Adaptor

The shared rail adaptor can be combined easily with end clamp kit to convert standard rail to shared rail to allow landscape mounting of PV panels on E-W rails.



Part Number	Description
K10176-001	Shared Rail Adaptor

Splice Kit Attaching to 3/8" rail slot (HR250 & HR300)



Part Number	Description
K10178-001	Grounding Rail Splice Kit, HR250/HR300 3/8" Slot, Clear
K10178-BK1	Grounding Rail Splice Kit, HR250/HR300 3/8" Slot, Black

SunTurf System Components

Splice Kit Attaching to 1/4" rail slot (HR250 & HR300)



Part Number	Description
K10177-001	Grounding Rail Splice Kit, HR250/HR300 1/4" Slot, Clear
K10177-BK1	Grounding Rail Splice Kit, HR250/HR300 1/4" Slot, Black

Rail End Caps

HR Rail End Caps are made of aluminum and provide a clean finished look to the system.



Part Number	Description
A20284-001/BK1	Rail End Cap, HR250, Clear/Black
A20297-001/BK1	Rail End Cap, HR300, Clear/Black

Grounding Lug

Completing our family of grounding products is our Grounding Lug, which self-grounds to the rail, ensuring proper grounding of the PV System per UL 2703 and NEC 690.47

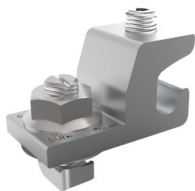

Part Number	Description
K10179-002	Grounding Lug

Cable Clip

Cable clips are compatible with HR250 and HR300.

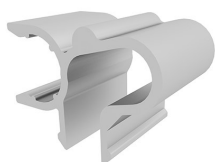

Part Number	Description
A20162-001	Cable Clip

SunTurf System Components

Swivel Pipe Cap Kit

This swivel pipe cap saves time and money by eliminating the need to grade the land before installing the PV array on sloped terrain.



Part Number	Description
K10373-001	Swivel Pipe Cap Kit

Pipe T-Clamp Kit

Position the T-Clamp Kit on top of the vertical pipe and lay the horizontal pipe into the Pipe Cap assembly.



Part Number	Description
K10341-002	2.5" Pipe T-Clamp Kit

Pipe Clamp Kit

The powder coated cast aluminum 2 piece clamps allows for quick installation of the braces, available in 2.0" and 2.5".



Part Number	Description
K10219-001	2" AL Pipe Clamp Kit
K10222-001	2.5" AL Pipe Clamp Kit

SunTurf System Components

Pipe U-Clamp Kit

Attach the rail to the pipe using the U-Clamp Kit. To prevent galvanic reaction between dissimilar metals, the included PVC Insulator must be installed between the steel pipe and the aluminum rail.



Part Number	Description
K10343-001	2.5" Pipe U-Clamp Kit (for HR250)
K10343-004	2.5" Pipe U-Clamp Kit (for HR300)

Pipe Splice Kit

Pipe Splice Kit provides bonding and strength between horizontal pipes when needed.

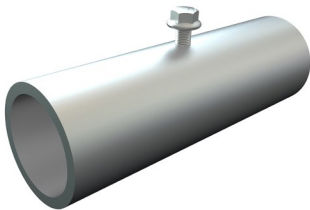

Part Number	Description
K10448-001	2.5" Pipe Splice Kit

Diagonal Brace

The diagonal tube brace provides extra support as needed.



Part Number	Description
A50164-066/092/120	HSS Tube Brace, 66"/92"/120" long

SunTurf System Components

Aluminum Post Base Plate Kit

Post Base Kits for 2.0" Aluminum Schedule 10 Post.

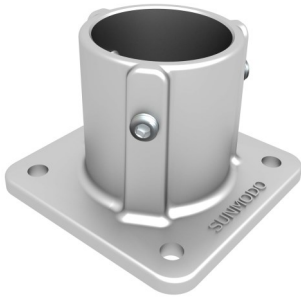

Part Number	Description
K10302-001	2" Al Post Base Plate Kit
K10302-002	2" OMG Al Post Base Plate Kit

Steel Post Base Plate Kit

The steel post base can be used where a more robust connection is needed to resist higher wind and seismic loads.



Part Number	Description
K10268-005	2" OD Steel Post Base Plate Kit

Embedment Ring

The concrete embedment rings are used to resist higher wind and seismic loads.

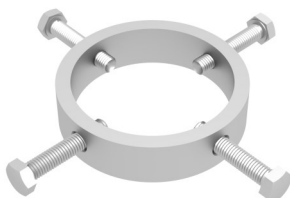

Part Number	Description
K10186-001	2" Embedment Ring Kit
K10186-002	2.5" Embedment Ring Kit

SunTurf System Components

Helical Earth Anchor

Helical earth augers are suitable for use in weak to moderate strength soils and areas with a high water table.



Part Number	Description
K10414-079	79" Helical Anchor, 79" Long

Ground Screw Anchor

Ground screw anchors are suitable for use in hard packed earth or soils with large amounts of cobble and gravel. Set screws are included.

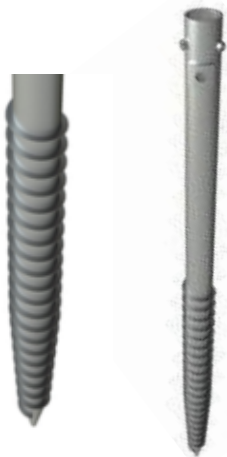

Part Number	Description
K10423-080	Screw Anchor, 80" Long
K10423-063	Screw Anchor, 63" Long

SunTurf System Components

Anchor Extension

SunModo provides 42" anchor extension to splice two pipes together.



Part Number	Description
A21148-042	42" Long Anchor extension

12-Gauge High Strength Steel (HSS) Pipe

SunModo provides either a 2" (2.375" O.D.) or 2.5" (2.875" O.D.) 12-gauge, HSS, hot dip galvanized pipe with a minimum 50 KSI yield strength. 2.5" HSS pipe end caps provide a clean finished look to the system.



Part Number	Description
A21165-060	2" 12-Gauge HSS Hot Dip Galvanized Pipe or equivalent, 60"
A21165-120	2" 12-Gauge HSS Hot Dip Galvanized Pipe or equivalent, 120"
A21168-166	2.5" 12-Gauge HSS Hot Dip Galvanized Pipe or equivalent, 166" long
A20380-001	2.5" HSS Pipe End Cap



SunModo, Corp.
Vancouver, Wash., USA
www.sunmodo.com
360.844.0048
info@sunmodo.com

RACKING PARTNER OF PROFESSIONAL INSTALLERS

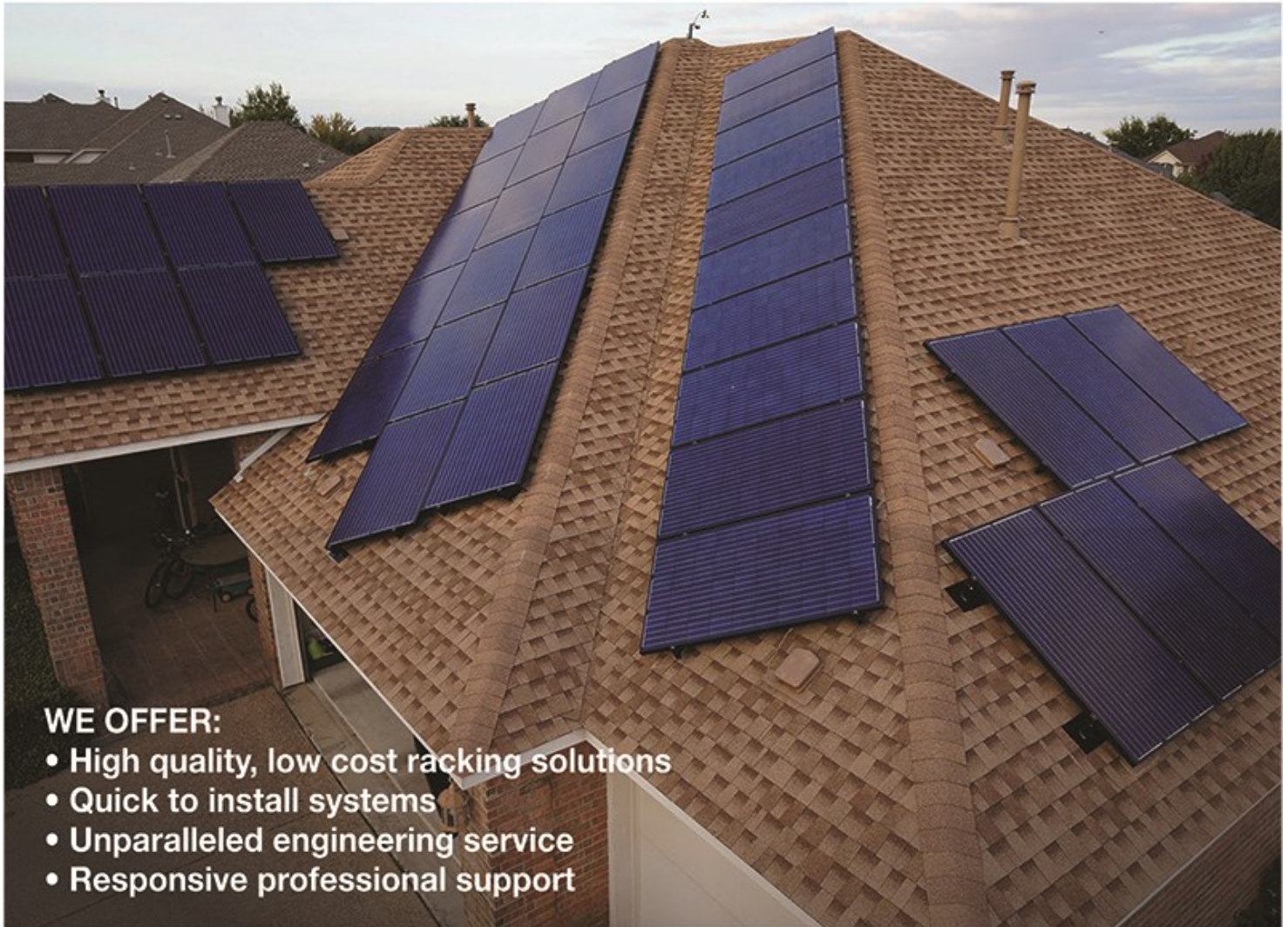

WE OFFER:

- High quality, low cost racking solutions
- Quick to install systems
- Unparalleled engineering service
- Responsive professional support

Solar installation professionals prefer to rely upon a single partner for all their mounting and racking needs. **SunModo** is dedicated to providing innovative racking solutions that help you install systems quickly and painlessly. Our products already set the standard for durability, safety and security, and our R&D team is constantly engineering affordable, hassle-reducing innovations that meet industry standards. You can access our products through our preferred distributors.

ABOUT SUNMODO

SunModo, meaning "*the way of the sun*," is a private U.S. company focused on innovative racking and mounting solutions for professional installers in the fast-growing solar industry. We are energized every day by a desire to make solar installation easier, more reliable and more affordable. Our commitment to innovation can be seen across our entire product line, which includes 14 industry-shaping patents.